

**CATALOGO DE RECAMBIOS
CABINA ALASKA RECT HIDROSAUNA**

Ed.01/09











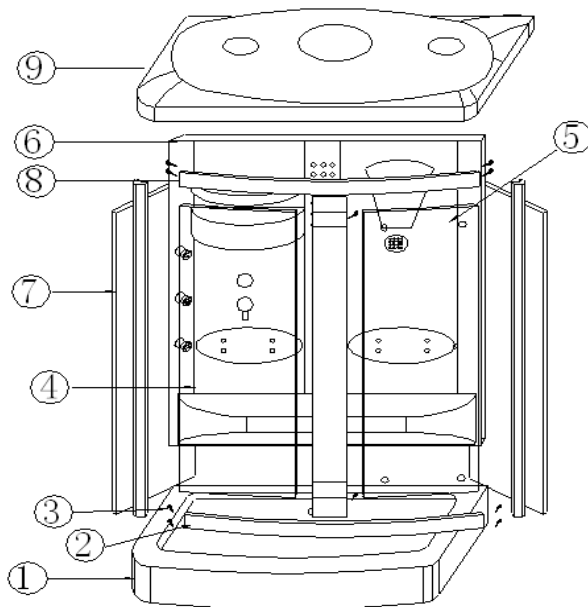

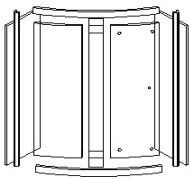



FOTO	REFERENCIA	DESCRIPCIÓN	DESCRIPTION	COD. EAN
	21001023	PLATO DE DUCHA	SHOWER BASE	8435124410237
	21001024	TECHO	ROOF	8435124410244
	21001025	PANEL TRASERO (CENTRAL) INCLUIDO SISTEMA ELECTR.	BACK PANEL (COMPLETE WITH ALL COMPONENTS)	8435124410251
	21000602	MAMPARA	GLASS BOX (COMPLETE)	8435124406025

	21001026	PERFIL LATERAL IZQUIERDO	ALUMINUM PROFILES (LEFT)	8435124410268
	21001027	PERFIL LATERAL DERECHO	ALUMINUM PROFILES (RIGHT)	8435124410275
	21001028	PERFIL CENTRAL	ALUMINUM PROFILES (FRONT)	8435124410282
	21001029	PROTECTORES DE PLÁSTICO	PLASTIC PROTECTION	8435124410299
	21001030	ESCUADRAS UNIÓN PERFILES	CONNECTION PROFILES	8435124410305
	21000604	PERFIL SUPERIOR	PROFILE ALUMINUM (UP PART)	8435124406049
	21001031	PERFIL INFERIOR	PROFILE ALUMINUM (DOWN PART)	8435124410312
	21000600	CRISTAL FIJO (FRONTAL)	FIXED GLASS	8435124406001

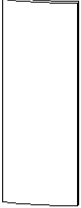
	21001032	PUERTA DE CRISTAL	GLASS DOOR	8435124410329
	21001033	CRISTAL FIJO IZQUIERDO MAMPARA C/ PERFIL INCORPORADO (Largo: 1767 mm)	FIX GLASS (LEFT)	8435124410336
	21001034	CRISTAL FIJO DERECHO MAMPARA C/ PERFIL INCORPORADO (Largo: 1767 mm)	FIX GLASS (RIGHT)	8435124410343
	21001035	PROTECTOR CON LENGÜETA DE SILICONA	SILICONE DOORS (1 SET)	8435124410350
	21001036	ROCIADOR DE TECHO	TOP SHOWER	8435124410367
	21001037	INYECTORES (JETS)	JETS	8435124410374
	21001038	RESPALDO LUMBAR	CUSHIONS	8435124410381
	21001039	PLAFÓN 365 mm) (Diámetro	CEILING	8435124410398

	21001040	ANILLO DE LEDS	LEDS	8435124410404
	21001041	PLACA DE LEDS (PANEL TRASERO)	BOARD LEDS (BACK PANNEL)	8435124410411
	21001270	SELECTOR DE FUNCIONES	SELECT FUNCTION	8435124412705
	21001271	MONOMANDO	FAUCET TEMPERATURE	8435124412712
	21000601	GRIFERÍA	FAUCET (COMPLETE)	8435124406018
	21001042	TAPA ALTAVOZ / EXTRACTOR	CAP OF SPEAKER / FAN	8435124410428
	21001043	REJILLA ALTAVOZ/EXTRACTOR	GRID SPEAKER/FAN	8435124410435
	21001044	ALTAVOZ (FICHA BLANCA)	SPEAKER	8435124410442

	21001045	VENTILADOR (FICHA NEGRA) RUNDA DC12V - 0,20A	FAN	8435124410459
	21001046	TORNILLERÍA	SCREW (COMPLETE)	8435124410466
	21000603	PANEL DE CONTROL MODELO: BF160A	CONTROL PANEL "BF160A"	8435124406032
	21000511	CAJA DE SISTEMA ELECTRICO (CPU) "BF160A"	ELECTRONIC SYSTEM (CPU) "BF160A"	8435124405110
	21001047	GENERADOR DE VAPOR	STEAM GENERATOR	8435124410473
	21001048	POMOS (PUERTAS)	HAND DOORS	8435124410480
	21001049	REPISA METÁLICA	METAL SHELF	8435124410497
	21001050	CONEXIÓN FLEJO DUCHA	SUPPORT FLEJO	8435124410503
	21001051	TELEFONO DUCHA	HAND SHOWER	8435124410510

	21001052	FLEJO DUCHA	FLEJO	8435124410527
	21001053	SOPORTE DE DUCHA	SUPPORT OF HAND SHOWER	8435124410534
	21001054	ESPEJO	MIRROR	8435124410541
	21001055	RODAMIENTOS	ROUNDS	8435124410558
	21001056	PROTECTOR CON CIERRE IMANTADO	MAGNETS DOORS (2 SET)	8435124410565
	21001057	DESAGÜE	DRAIN	8435124410572
	21001058	TUBO DE DESAGÜE	DRAIN TUBE	8435124410589
	21001059	LATIGUILLO DE CONEXIÓN AGUA FRIA/CALIENTE (AZUL/ROJO) (1,20 cm LARGO)	HOSE WATER CONNECTION (1,20 cm LENGTH)	8435124410596
	21001060	MANGUITO DE CONEXIÓN ROCIADOR (1,25 cm Largo)	HOSE CONNECTION OF TOP SHOWER (1,25 cm Length)	8435124410602
	21001061	MNGUITO CONEXIÓN MASAJEADOR DE PIES (1,35 cm Largo)	HOSE CONNECTION OF FOOT MASSAGE (1,35 cm Length)	8435124410619
	21001062	MANGUITO DE CONEXIÓN TELEFONO DE DUCHA (80 cm Largo)	HOSE CONNECTION OF HAND SHOWER (80 cm Length)	8435124410626
	21001069	MANGUITO CONEXIÓN DESAGÜE DEL GENERADOR	HOSE CONNECTION DRAIN GENERATOR	8435124410695

	21001063	MANGUITO CON PROTECCIÓN TÉRMICA	HOSE OF STEAM	8435124410633
	21001064	MANGUERA CONEXIÓN ENTRADA AGUA AL GENERADOR	HOSE CONNECTION WATER INLET OF GENERATOR	8435124410640
	21001065	CONEXIÓN JETS LUMBARES	MINI JETS CONNECTION	8435124410657
	21001066	CODO DE CONEXIONES	CONNECTION OF HOSE WATER	8435124410664
	21001067	SALIDA DE VAPOR	STEAM SPRAY	8435124410671
	21001068	MASAJEADOR DE PIES	FOOT MASSAGE	8435124410688